

Modular “Building Block” Clutches

GFR®/GFRN

Overrunning, Indexing, Backstopping Ball Bearing Supported, Ramp & Roller Clutches

GFR

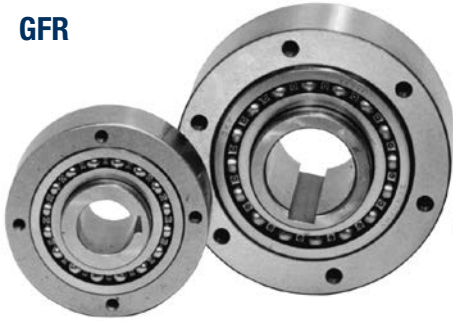

GFRN

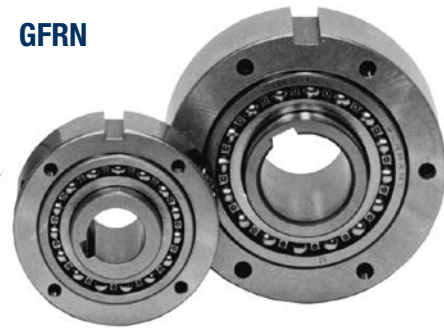

The GFR and GFRN are part of the Stieber modular system. They are bearing supported, using two 160 Series bearings, and require oil lubrication. These units may be used in designs providing oil lubrication and sealing as shown on the following pages.

The bearings must not be axially stressed. Typically, models GFR and GFRN are used with the F series covers that are designed to transmit torque and retain oil lubrication.

Usually, these covers are used in pairs according to combinations shown on the following pages.

The outer race of the GFR model is designed to support and center any

component bored to H7 tolerance. Torque is transmitted by bolts through the cover plate in this case. Models GFR and GFRN are identical, except that model GFRN has a keyseat on the outside diameter to transmit torque.

Two paper seals are shipped with each unit to be placed between the outer race and cover plates.

This clutch is designed for oil lubrication. For grease lubrication, reduce the maximum overrunning speed to 50% of listed value.

For bolt tightening torque values, see page 134.

For Indexing Applications:

Maximum number indexes per minute is 350.

Specifications

Size	Torque Capacity lb.ft. (Nm)	Overrunning Speed Max. RPM		Shipping Weight lb. (kg)
		Inner Race	Outer Race	
12	41 (55)	4,000	5,600	1.1 (0.5)
15	92 (125)	3,600	5,200	1.76 (0.8)
20	134 (181)	2,700	4,600	2.21 (1)
25	213 (288)	2,100	3,600	3.31 (1.5)
30	369 (500)	1,700	3,200	4.85 (2.2)
35	535 (725)	1,550	3,000	6.62 (3)
40	756 (1025)	1,150	2,600	10.14 (4.6)
45	830 (1125)	1,000	2,400	10.36 (4.7)
50	1,568 (2125)	800	2,150	15.88 (7.2)
55	1,937 (2625)	750	2,000	18.96 (8.6)
60	2,583 (3500)	650	1,900	23.15 (10.5)
70	4,244 (5750)	550	1,750	29.77 (13.5)
80	6,273 (8500)	500	1,600	40.13 (18.2)
90	10,701 (14500)	450	1,450	62.84 (28.5)
100	14,760 (20000)	350	1,250	93.71 (42.5)
130	23,063 (31250)	250	1,000	143.33 (65)
150	51,660 (70000)	200	800	304.29 (138)

Note: Keyway to DIN 6885.1

Modular "Building Block" Clutches

GFR/GFRN

GFR

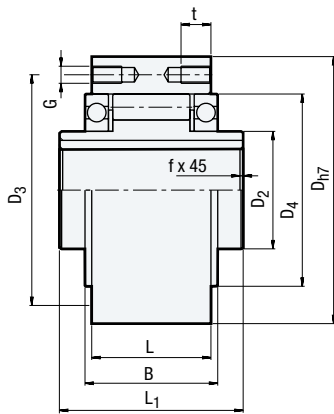

GFRN

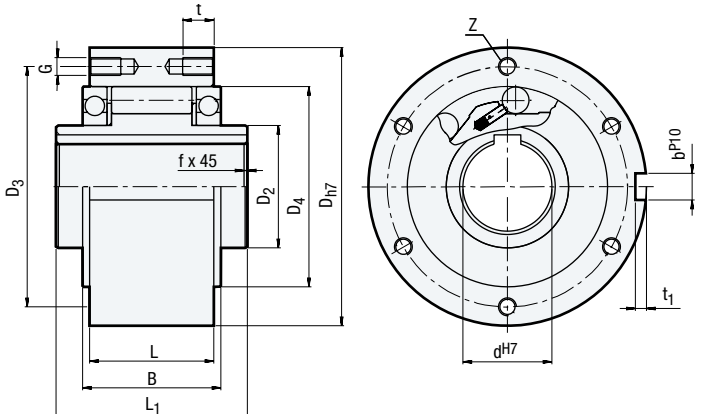

Dimensions inches (mm)

Size	d ^{H7}	D _{h7}	D ₂	D ₄	D ₃	t	L ₁	L	B	t ₁	b ^{P10}	f	G	Z
12	0.47 (12)	2.44 (62)	0.79 (20)	1.65 (42)	2.01 (51)	— (—)	1.65 (42)	0.79 (20)	1.06 (27)	0.10 (2.5)	0.16 (4)	1.10 (0.5)	(5.5)	2
15	0.59 (15)	2.68 (68)	0.98 (25)	1.85 (47)	2.20 (56)	0.31 (8)	2.05 (52)	1.10 (28)	1.26 (32)	0.12 (3)	0.20 (5)	0.03 (0.8)	M5	3
20	0.79 (20)	2.95 (75)	1.18 (30)	2.17 (55)	2.52 (64)	0.31 (8)	2.24 (57)	1.34 (34)	1.54 (39)	0.14 (3.5)	0.24 (6)	0.03 (0.8)	M5	3
25	0.98 (25)	3.54 (90)	1.57 (40)	2.68 (68)	3.07 (78)	0.39 (10)	2.36 (60)	1.38 (35)	1.57 (40)	0.16 (4)	0.31 (8)	0.04 (1)	M6	4
30	1.18 (30)	3.94 (100)	1.77 (45)	2.95 (75)	3.43 (87)	0.39 (10)	2.68 (68)	1.69 (43)	1.89 (48)	0.16 (4)	0.31 (8)	0.04 (1)	M6	4
35	1.38 (35)	4.33 (110)	1.97 (50)	3.15 (80)	3.78 (96)	0.47 (12)	2.91 (74)	1.77 (45)	2.01 (51)	0.20 (5)	0.39 (10)	0.04 (1)	M6	6
40	1.57 (40)	4.92 (125)	2.17 (55)	3.54 (90)	4.25 (108)	0.55 (14)	3.39 (86)	2.09 (53)	2.32 (59)	0.20 (5)	0.47 (12)	0.06 (1.5)	M8	6
45	1.77 (45)	5.12 (130)	2.36 (60)	3.74 (95)	4.41 (112)	0.55 (14)	3.39 (86)	2.09 (53)	2.32 (59)	0.22 (5.5)	0.55 (14)	0.06 (1.5)	M8	6
50	1.97 (50)	5.91 (150)	2.76 (70)	4.33 (110)	5.20 (132)	0.55 (14)	3.70 (94)	2.52 (64)	2.83 (72)	0.22 (5.5)	0.55 (14)	0.06 (1.5)	M8	8
55	2.17 (55)	6.30 (160)	2.95 (75)	4.53 (115)	5.43 (138)	0.63 (16)	4.09 (104)	2.60 (66)	2.83 (72)	0.24 (6)	0.63 (16)	0.08 (2)	M10	8
60	2.36 (60)	6.69 (170)	3.15 (80)	4.92 (125)	5.91 (150)	0.63 (16)	4.49 (114)	3.07 (78)	3.50 (89)	0.28 (7)	0.71 (18)	0.08 (2)	M10	10
70	2.76 (70)	7.48 (190)	3.54 (90)	5.51 (140)	6.50 (165)	0.63 (16)	5.28 (134)	3.74 (95)	4.25 (108)	0.30 (7.5)	0.79 (20)	0.10 (2.5)	M10	10
80	3.15 (80)	8.27 (210)	4.13 (105)	6.30 (160)	7.28 (185)	0.63 (16)	5.67 (144)	3.94 (100)	4.25 (108)	0.35 (9)	0.87 (22)	0.10 (2.5)	M10	10
90	3.54 (90)	9.06 (230)	4.72 (120)	7.09 (180)	8.11 (206)	0.79 (20)	6.22 (158)	4.53 (115)	4.92 (125)	0.35 (9)	0.98 (25)	0.12 (3)	M12	10
100	3.94 (100)	10.63 (270)	5.51 (140)	8.27 (210)	9.45 (240)	0.94 (24)	7.17 (182)	4.72 (120)	5.16 (131)	0.39 (10)	1.10 (28)	0.12 (3)	M16	10
130	4.72 (120)	12.20 (310)	6.30 (160)	9.45 (240)	10.94 (278)	0.94 (24)	8.35 (212)	5.98 (152)	6.61 (168)	0.43 (11)	32 (1.26)	0.12 (3)	M16	12
150	5.91 (150)	15.75 (400)	7.87 (200)	12.20 (310)	14.17 (360)	1.26 (32)	9.69 (246)	7.09 (180)	7.64 (194)	0.47 (12)	1.42 (36)	0.16 (4)	M20	12

Note: GFR 12 has through holes in outer race.

Bore sizes and keyseats inches (mm)

Size	d ^{H7} Bore Size	Keyseat*
12	0.47 (12)	(4 X 1.8)
15	0.59 (15)	(5 X 2.3)
20	0.79 (20)	(6 X 2.8)
25	0.98 (25)	(8 X 3.3)
30	1.18 (30)	(8 X 3.3)
35	1.38 (35)	(10 X 3.3)
40	1.57 (40)	(12 X 3.3)
45	1.77 (45)	(14 X 3.8)
50	1.97 (50)	(14 X 3.8)
55	2.17 (55)	(16 X 4.3)
60	2.36 (60)	(18 X 4.4)
70	2.76 (70)	(20 X 4.9)
80	3.15 (80)	(22 X 5.4)
90	3.54 (90)	(25 X 5.4)
100	3.94 (100)	(28 X 6.4)
130	5.12 (130)	(32 X 7.4)
150	5.91 (150)	(36 X 8.4)

* For keyseat sizes see DIN 6885.1 table on page 129.